

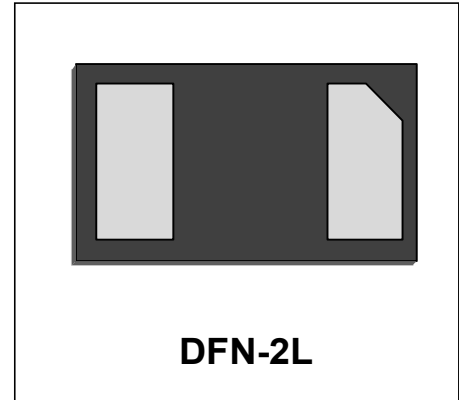

Features

- Protects one I/O or Power Line
- Low Clamping Voltage
- Working Voltage: 5V
- Low Leakage Current
- Response Time is Typically < 1 ns



IEC Compatibility (EN61000-4)

- IEC 61000-4-2 (ESD) $\pm 30\text{kV}$ (air), $\pm 30\text{kV}$ (contact)
- IEC 61000-4-4 (EFT) 40A (5/50ns)

Mechanical Characteristics

- DFN-2L package
- Molding compound flammability rating: UL 94V-0
- Marking : Marking Code
- RoHS Compliant

Applications

- Cellular Handsets & Accessories
- Personal Digital Assistants (PDAs)
- Notebooks & Handhelds
- Portable Instrumentation
- Digital Cameras
- MP3 Players

Schematic & PIN Configuration

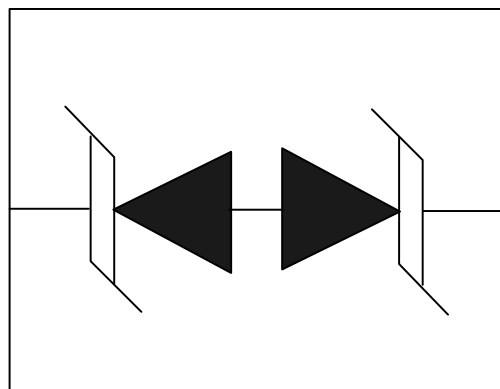

Absolute Maximum Rating			
Rating	Symbol	Value	Units
Peak Pulse Power ($t_p = 8/20\mu s$)	P_{PP}	100	Watts
Operating Temperature	T_J	-55 to + 125	$^{\circ}C$
Storage Temperature	T_{STG}	-55 to +150	$^{\circ}C$

Electrical Parameters (T=25 $^{\circ}C$)

Symbol	Parameter
I_{PP}	Reverse Peak Pulse Current
V_C	Clamping Voltage @ I_{PP}
V_{RWM}	Working Peak Reverse Voltage
I_R	Reverse Leakage Current @ V_{RWM}
V_{BR}	Breakdown Voltage @ I_T
I_T	Test Current

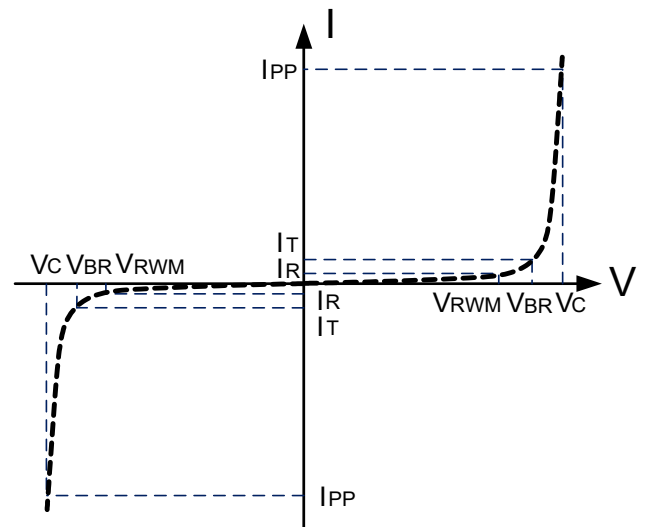

Electrical Characteristics

DW05DF-BN-E						
Parameter	Symbol	Conditions	Minimum	Typical	Maximum	Units
Reverse Stand-Off Voltage	V_{RWM}				5.0	V
Reverse Breakdown Voltage	V_{BR}	$I_T=1mA$	6.0			V
Reverse Leakage Current	I_R	$V_{RWM}=5V, T=25^{\circ}C$			200	nA
Peak Pulse Current	I_{PP}	$t_p=8/20\mu s$			5	A
Clamping Voltage	V_C	$I_{PP}=1A, t_p=8/20\mu s$			9.5	V
Clamping Voltage	V_C	$I_{PP}=5A, t_p=8/20\mu s$		13	15	V
Junction Capacitance	C_j	$V_R=0V, f=1MHz$		7	10	pF

Typical Characteristics

Figure 1: Peak Pulse Power Vs Pulse Time

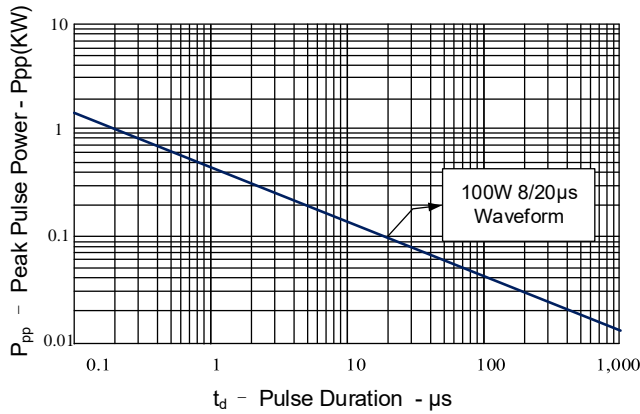

Figure 2: Power Derating Curve

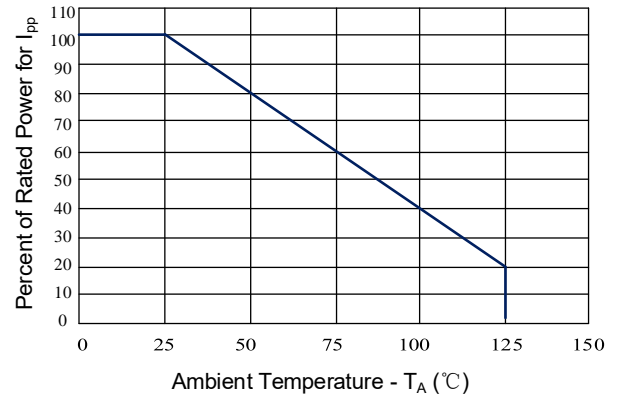

Figure 3: Clamping Voltage vs. Peak Pulse Current

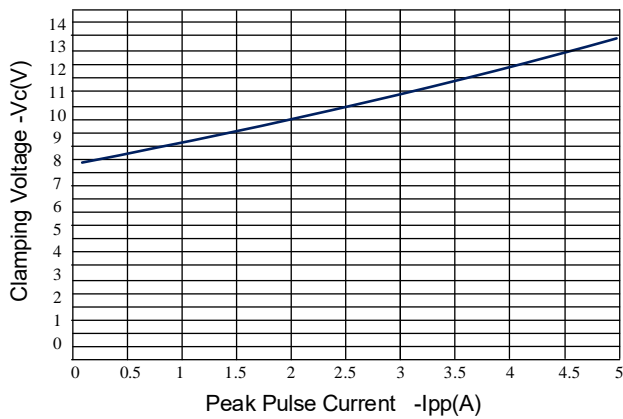

Figure 4: Normalized Junction Capacitance vs. Reverse Voltage

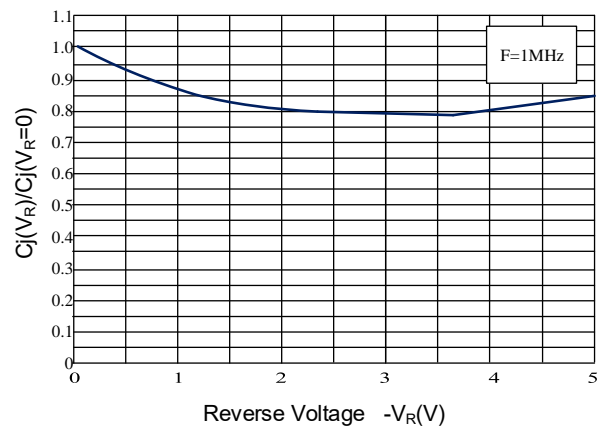

Figure 5: Pulse Waveform

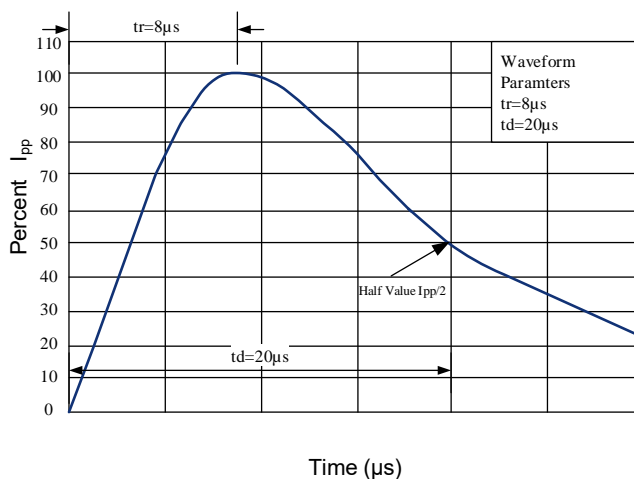
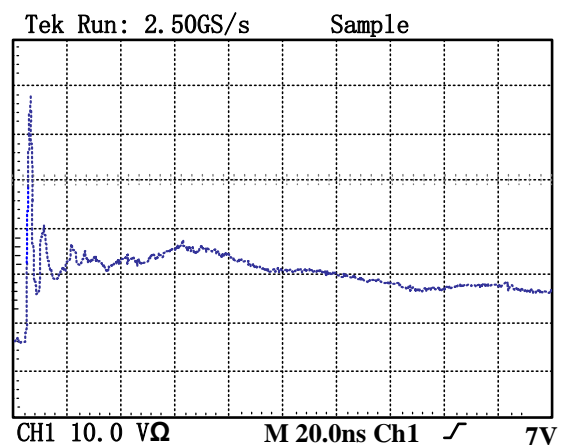
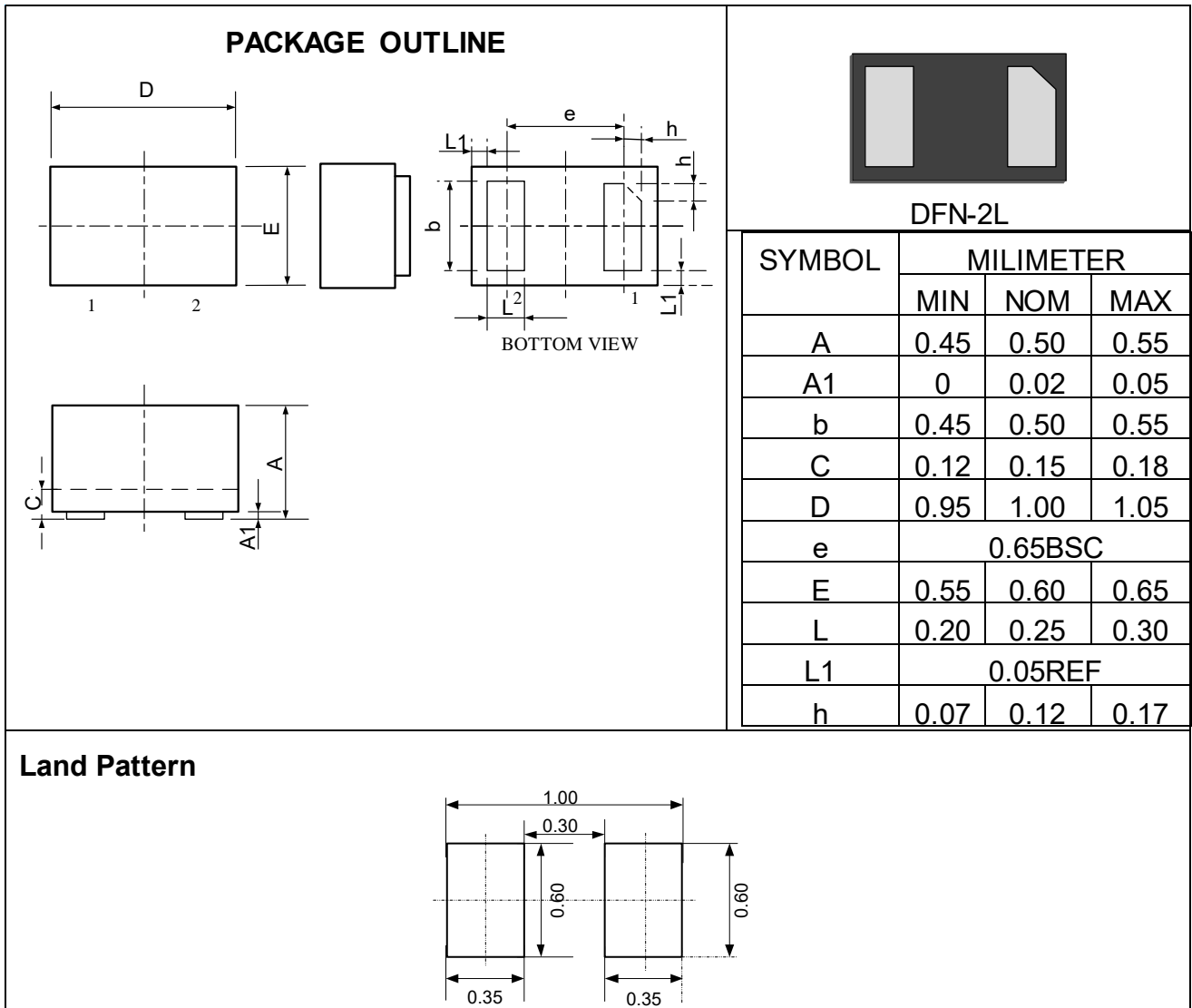

Figure 6: ESD Clamping(8kV Contact per IEC 61000-4-2)





Outline Drawing –DFN-2L



Marking Codes

Part Number	DW05DF-BN-E	Marking Code	PB
-------------	-------------	--------------	----

Package Information

Qty: 10k/Reel